

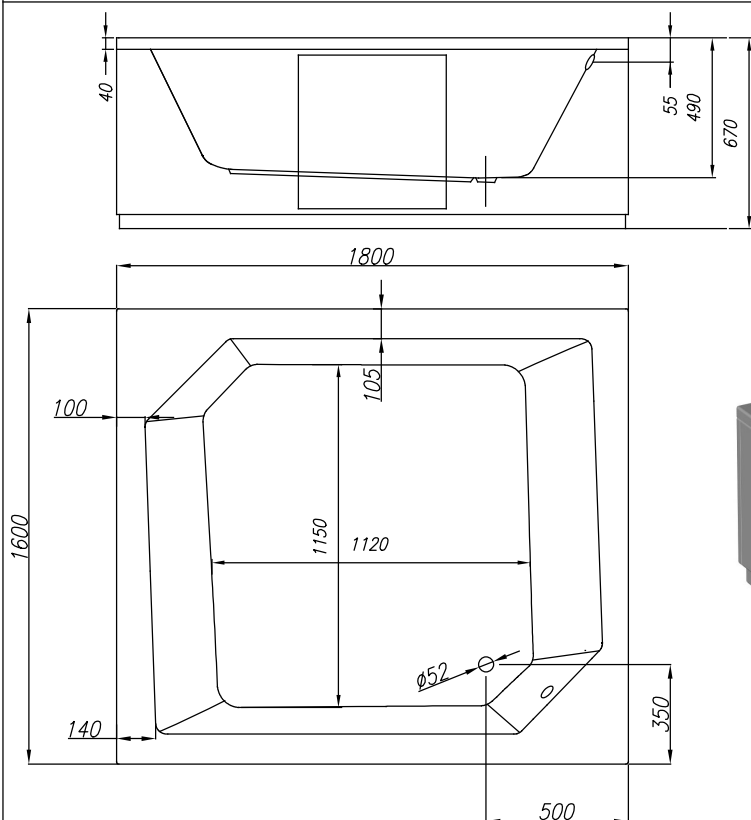

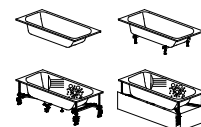

**Samson 180x160**

**PREDINSTALACIJA  
PREINSTALLATION  
VORINSTALLATION**

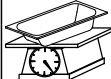
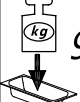
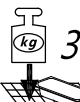

 <b>650 L</b>	<b>VOLUMEN VOLUMEN VOLUME VOLUMEN</b>	 <b>58 kg</b>	<b>TEŽA TEŽINA WEIGHT GEWICHT</b>	 <b>990 kg</b>	<b>MAX. OBREMENITEV MAX. OBTEREČENJE MAX. LOAD MAX. BELASTUNG</b>	 <b>340 kg/m<sup>2</sup></b>	<b>OBREMENITEV TAL OBTEREČENJE PODA FLOOR LOAD BODENBELASTUNG</b>
------------------------------------------------------------------------------------------------	---------------------------------------------------	--------------------------------------------------------------------------------------------------	-----------------------------------------------	--------------------------------------------------------------------------------------------------	-------------------------------------------------------------------------------	------------------------------------------------------------------------------------------------------------------	-------------------------------------------------------------------------------

-  - Prostor za električni vodnik 3x2,5 mm<sup>2</sup>, dolžine pribl. 1 m
- Mjesto za električni vodnik 3x2,5 mm<sup>2</sup>, dužine cca. 1 m
- Spot for electrical cable 3x2,5 mm<sup>2</sup>, length approx. 1 m
- Platz Stromkabel 3x2,5 mm<sup>2</sup>, Länge ungefähr 1 m

---

-  - Prostor za električni vodnik 1x6 mm<sup>2</sup> za ozemljitev, dolžine pribl. 1,5 m
- Mjesto za električni vodnik 1x6 mm<sup>2</sup> za ozemljenje, dužine cca. 1,5 m
- Spot for electrical cable 1x6 mm<sup>2</sup> for earthing, length approx. 1,5 m
- Platz Stromkabel 1x6 mm<sup>2</sup> für Erdung, Länge ungefähr 1,5 m

---

-  - Priklop tople in hladne vode 1/2", min 0,2 Mpa, max 0,4 Mpa
- Priključak tople i hladne vode 1/2", min 0,2 Mpa, max 0,4 Mpa
- Connection of hot and cold water 1/2", min 0,2Mpa, max 0,4Mpa
- Anschluss Warm- und Kaltwasser 1/2", min 0,2 Mpa, max 0,4 Mpa

---

-  - Prostor za odtok Ø 50 mm
- Mjesto za odtok Ø 50 mm
- Drain spot Ø 50mm
- Abflussplatz Ø 50 mm

---

-  - Opcija - obloga
- Opcija - obloga
- Option - panel
- Möglichkeit - Schürze

*priporočilo za vgradnjo  
preporuka za ugradnju  
installation recommendation  
Einbauempfehlung*

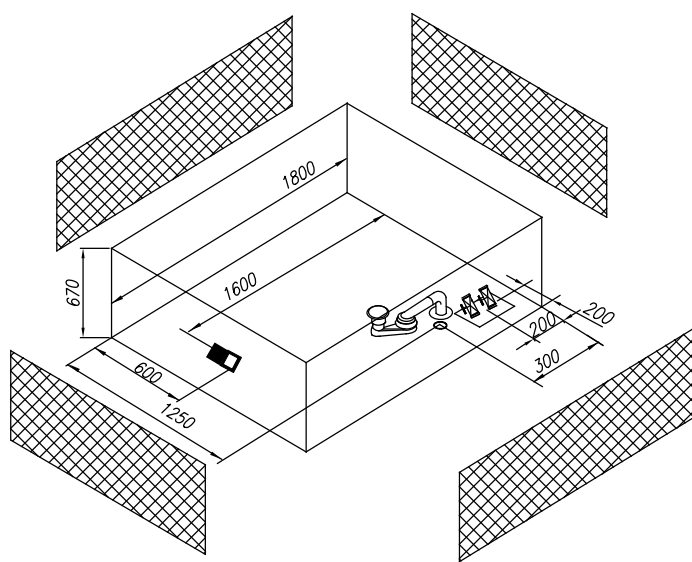

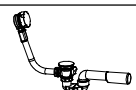
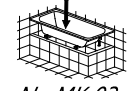
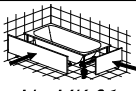
<p>Priporočena prelivna garnitura Preporuka prelivne garniture Recommended overflow set Vorgeschlagene Überlaufgarnitur</p>		<b>PAL 650</b>
<p>kopalna kad brez oblog - navodilo za vgradnjo Kada bez obloge - upute za ugradnju Bathtub without panel - installation instructions Badewanne ohne Schürze - Einbauanleitung</p>		<p>Opcija podnožja za kadi brez obloge Varianta postolja za kade bez obloge Option of the built-in bathtub base Möglichkeit des Sockels für die Badewannen ohne Schürze</p>
<p>Kopalna kad z oblogo - navodilo za vgradnjo Kada s oblogom - upute za ugradnju Bathtub with panel - installation instructions Badewanne mit Schürze - Einbauanleitung</p>		<p>Opcija podnožja za kadi z oblogo Varianta postolja za kade sa oblogom Option of the bathtub base with panel Möglichkeit des Sockels für die Badewannen mit Schürze</p>
		<p><b>Nr. MK 03</b></p> <p><b>Nr. MK 01</b></p> <p><b>Nr. MK 10 2x PKK 800</b></p> <p>sestavljeno sastavljeno pre-assembled vormontiert</p>



- MEŠALNI VENTIL TOPLA/HLADNA  
- VENTIL ZA MIEŠANJE TOPLO/HLADNO  
- MIXING VALVE HOT/COLD  
- MISCHVENTIL WARM/KALT



- PREKLOPNIK ROČNA PRHA/IZLIV  
- PREKIDAČ ZA RUČNI TUŠ/IZLJEV  
- HAND SHOWER/SPOUT SELECTOR SWITCH  
- SCHALTER FÜR HANDBRAUSE/AUSLAUF

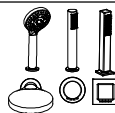

- ROČNA PRHA  
- RUČNI TUŠ  
- HAND SHOWER  
- HANDBRAUSE

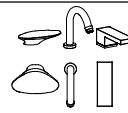

- IZLIV  
- IZLJEVNIK  
- SPOUT  
- AUSLAUF



- IZLIV NA PRELIVNI GARNITURI  
- IZLJEV NA PRELJEVNOM SETU  
- SPOUT ON THE OVERFLOW SET  
- AUSLAUF AN DER ÜBERLAUFGARNITUR

- OPCIJA ENOROČNA ARMATURA WATERFALL
- OPCIJA JEDNORUČNA ARMATURA WATERFALL
- OPTION ONE HAND FITTING WATERFALL
- MÖGLICHKEIT EINWEG-ARMATUR WATERFALL

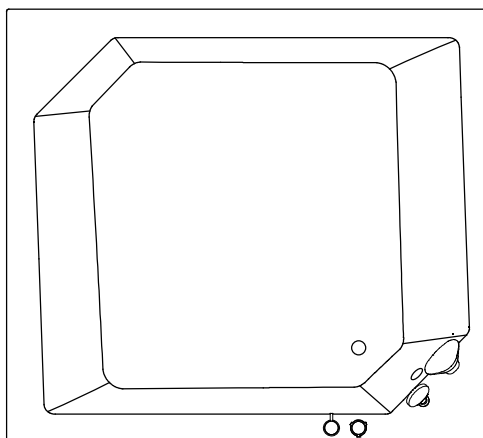
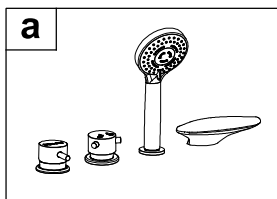

- OPCIJA ENOROČNA ARMATURA GEYSER
- OPCIJA JEDNORUČNA ARMATURA GEYSER
- OPTION ONE HAND FITTING GEYSER
- MÖGLICHKEIT EINWEG-ARMATUR GEYSER

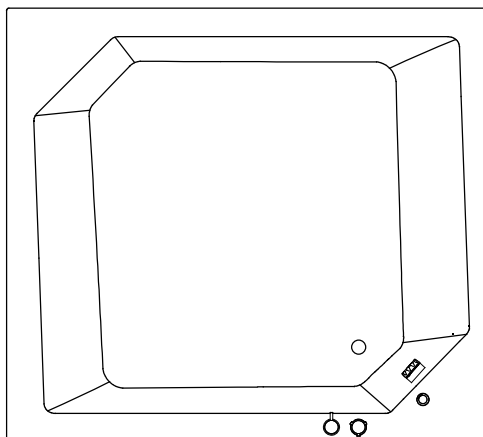
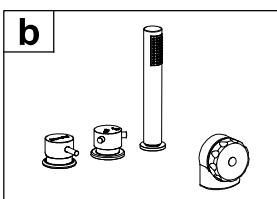

- OPCIJA ENOROČNA ARMATURA RAINDROP
- OPCIJA JEDNORUČNA ARMATURA RAINDROP
- OPTION ONE HAND FITTING RAINDROP
- MÖGLICHKEIT EINWEG-ARMATUR RAINDROP

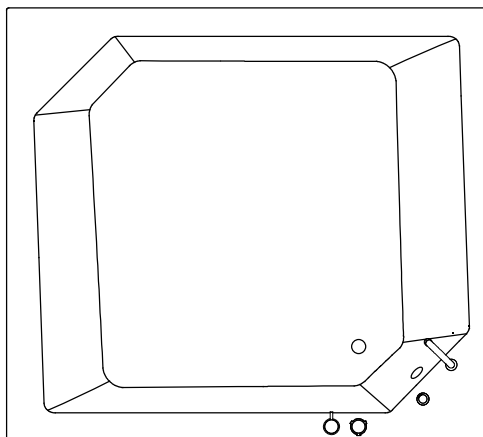
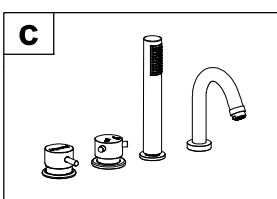

- OPCIJA ENOROČNA ARMATURA STREAM (CHR / BLACK)
- OPCIJA JEDNORUČNA ARMATURA STREAM (CHR / BLACK)
- OPTION ONE HAND FITTING STREAM (CHR / BLACK)
- MÖGLICHKEIT EINWEG-ARMATUR STREAM (CHR / BLACK)

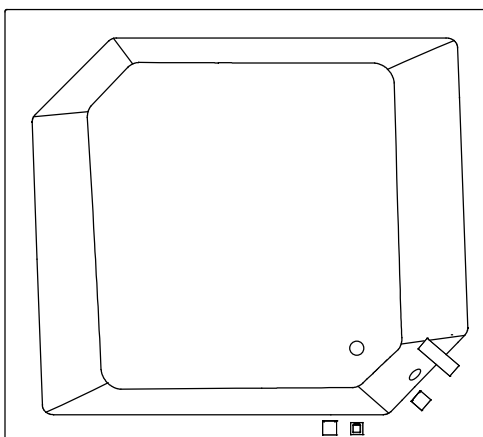
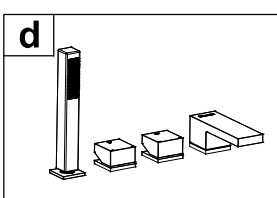

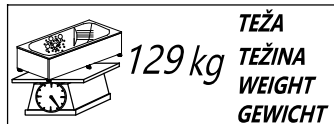
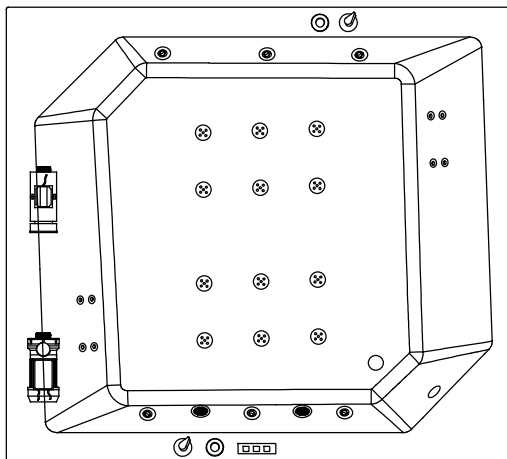
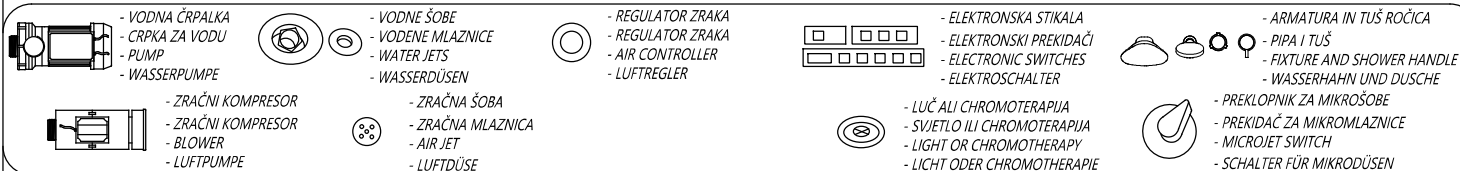

**VODNI IN ZRAČNI  
 MASAŽNI SISTEM**

- VODNA ČRPALKA P= 1250W
- ZRAČNI KOMPRESOR P=800W
- ELEKTRONSKO STIKALO
- 6 SUPER VODNIH ŠOB
- 12 ZRAČNIH ŠOB
- 2x4 MIKROŠOBE ZA HRBET
- REGULATOR ZRAKA

**VODENI I ZRAČNI  
 MASAŽNI SISTEM**

- CRPKA ZA VODU P= 1250W
- ZRAČNI KOMPRESOR P=800W
- ELEKTRONSKI PREKIDAČ
- 6 SUPER MLAZNICA ZA VODU
- 12 ZRAČNIH MLAZNICA
- 2x4 MIKROMLAZNICA ZA LEDA
- REGULATOR ZRAKA

**WATER AND AIR  
 MASSAGE SYSTEM**

- PUMP P=1250W
- BLOWER P=800W
- ELECTRONIC SWITCH
- 6 SUPER WATER JETS
- 12 AIR JETS
- 2x4 MICROJETS FOR BACK
- AIR REGULATOR

**WASSER UND LUFT  
 MASSAGESYSTEM**

- WASSERPUMPE P = 1250 W
- LUFTPUMPE P = 800 W
- ELEKTROSCHALTER
- 6 SUPER-WASSERDÜSEN
- 12 LUFTDÜSEN
- 2x4 MIKRODÜSEN FÜR RÜCKEN
- LUFTREGLER

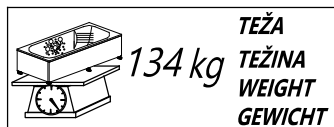
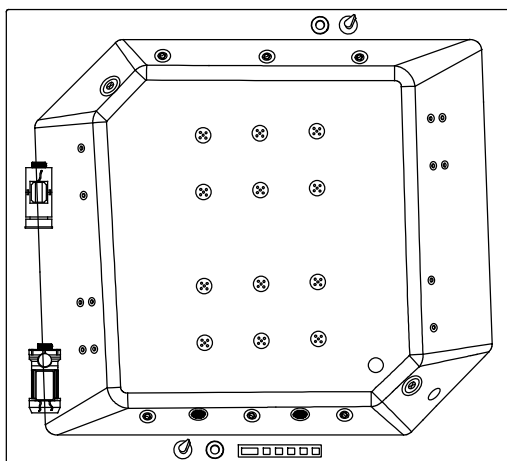

**VITAL MASAŽNI SISTEM**

- VODNA ČRPALKA P=1250W
- ZRAČNI KOMPRESOR P=800W
- GRELEC P=1500W
- ELEKTRONSKO STIKALO
- 2x REGULATOR ZRAKA
- 6 SUPER VODNIH ŠOB
- 12 ZRAČNIH ŠOB
- OZON ZA DEZINFEKCIJO
- CHROMOTERAPIJA
- 2x4 MIKROŠOB ZA HRBET
- 2x2 MIKROŠOBI ZA NOGE

**VITAL MASAŽNI SISTEM**







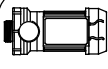

- CRPKA ZA VODU P=1250W
- ZRAČNI KOMPRESOR P=800W
- GRIJAČ P=1500W
- ELEKTRONSKI PREKIDAČ
- 2x REGULATOR ZRAKA
- 6 SUPER VODNIH MLAZNICA
- 12 ZRAČNIH MLAZNICA
- OZON ZA DEZINFEKCIJU
- CHROMOTERAPIJA
- 2x4 MIKROMLAZNICA ZA LEDA
- 2x2 MIKROMLAZNICE ZA NOGE

**VITAL MASSAGE SYSTEM**

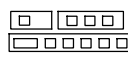
- PUMP P=1250W
- BLOWER P=800W
- HEATER P=1500W
- ELECTRONIC SWITCH
- 2x AIR CONTROLLER
- 6 SUPER WATER JETS
- 12 AIR JETS
- OZONE FOR DISINFECTION
- CHROMOTHERAPY
- 2x4 MICROJETS FOR BACK
- 2x2 MICROJETS FOR FEET

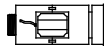
**VITAL MASSAGESYSTEM**

- WASSERPUMPE P = 1250 W
- LUFTPUMPE P = 800 W
- HEIZKÖRPER P = 1500 W
- ELEKTROSCHALTER
- 2x LUFTREGLER
- 6 SUPER WASSERDÜSEN
- 12 LUFTDÜSEN
- OZON FÜR DESINFEKTION
- CHROMOTHERAPIE
- 2x4 MIKRODÜSEN FÜR RÜCKEN
- 2x2 MIKRODÜSEN FÜR FÜSSE

- |                                                                                                                                                      |                                                                                                                                                     |                                                                                                                                                                              |                                                                                                                                                                                                       |                                                                                                                                                                                                |
|------------------------------------------------------------------------------------------------------------------------------------------------------|-----------------------------------------------------------------------------------------------------------------------------------------------------|------------------------------------------------------------------------------------------------------------------------------------------------------------------------------|-------------------------------------------------------------------------------------------------------------------------------------------------------------------------------------------------------|------------------------------------------------------------------------------------------------------------------------------------------------------------------------------------------------|
|  - VODNA ČRPALKA<br>- CRPKA ZA VODU<br>- PUMP<br>- WASSERPUMPE       |  - VODNE ŠOBE<br>- VODNE MLAZNICE<br>- WATER JETS<br>- WASSERDÜSEN |  - REGULATOR ZRAKA<br>- REGULATOR ZRAKA<br>- AIR CONTROLLER<br>- LUFTRGLER                  |  - ELEKTRONSKA STIKALA<br>- ELEKTRONSKI PREKIDAČI<br>- ELECTRONIC SWITCHES<br>- ELEKTROSCHALTER                      |  - ARMATURA IN TUŠ ROČICA<br>- PIPA I TUŠ<br>- FIXTURE AND SHOWER HANDLE<br>- WASSERHAHN UND DUSCHE         |
|  - ZRAČNI KOMPRESOR<br>- ZRAČNI KOMPRESOR<br>- BLOWER<br>- LUFTPUMPE |  - ZRAČNA ŠOBA<br>- ZRAČNA MLAZNICA<br>- AIR JET<br>- LUFTDÜSE     |  - PNEVMATSKO STIKALO<br>- PNEVMATSKI PREKIDAČ<br>- PNEUMATIC SWITCH<br>- PNEUMATIKSCHALTER |  - LUČ ALI CHROMOTERAPIJA<br>- SVJETLO ILI CHROMOTERAPIJA<br>- LIGHT OR CHROMOTHERAPY<br>- LICHT ODER CHROMOTHERAPIE |  - PREKLOPNIK ZA MIKROŠOBE<br>- PREKIDAČ ZA MIKROMLAZNICE<br>- MICROJET SWITCH<br>- SCHALTER FÜR MIKRODÜSEN |

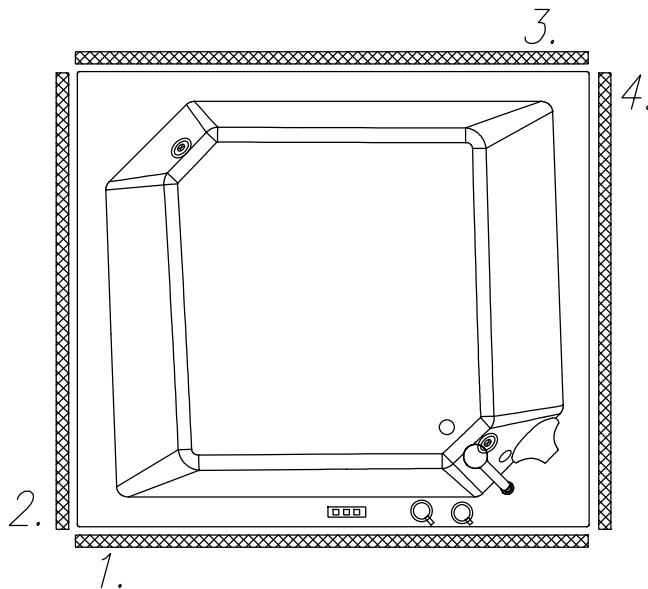

**OPCIJE**

- OPCIJA CHROMOTERAPIJA

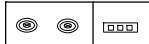

- POLOŽAJ OBLOG NA KOPALNI KADI



- Opcija 2 oblogi = 1+2
- Opcija 3 obloge = 1+2+4
- Opcija 4 obloge = 1+2+3+4

**OPCIJE**

- OPCIJA CHROMOTERAPIJA



- POZICIJA OBLOGE NA KADI



- Opcija 2 obloge = 1+2
- Opcija 3 obloge = 1+2+4
- Opcija 4 obloge = 1+2+3+4

**OPTIONS**

- OPTION CHROMOTHERAPY



- PANEL POSITIONS ON THE BATH



- Option 2 panels = 1+2
- Option 3 panels = 1+2+4
- Option 4 panels = 1+2+3+4

**MÖGLICHKEITEN**

- MÖGLICHKEIT CHROMOTHERAPIE



- POSITION DER SHÜRZE FÜR BADEWANNE



- Möglichkeit 2 Shürze = 1+2
- Möglichkeit 3 Shürze = 1+2+4
- Möglichkeit 4 Shürze = 1+2+3+4